

SK210LC		Standard Arm: 2.94 m Bucket: Without Shoe: 600 mm Counterweight: 4,300 kg												
B	A	1.5 m		3.0 m		4.5 m		6.0 m		7.5 m		At Max. Reach		Radius
		Icon	Icon	Icon	Icon	Icon	Icon	Icon	Icon	Icon	Icon	Icon	Icon	
7.5 m	kg							*4,830	*4,830			*3,880	*3,880	6.26 m
6.0 m	kg							*5,330	5,240			*3,590	*3,590	7.36 m
4.5 m	kg							*5,810	5,060	*5,340	3,530	*3,510	3,130	8.03 m
3.0 m	kg					*8,460	7,330	*6,580	4,790	5,320	3,420	*3,580	2,860	8.38 m
1.5 m	kg					*9,970	6,790	7,250	4,530	5,180	3,290	*3,790	2,750	8.45 m
G. L.	kg			*5,760	*5,760	*10,670	6,490	7,050	4,340	5,070	3,200	*4,190	2,800	8.25 m
-1.5 m	kg	*6,100	*6,100	*10,060	*10,060	*10,510	6,410	6,960	4,270	5,050	3,170	4,830	3,040	7.75 m
-3.0 m	kg	*10,670	*10,670	*13,190	12,640	*9,500	6,480	7,010	4,310			*5,700	3,620	6.89 m
-4.5 m	kg			*9,760	*9,760	*7,160	6,730					*5,380	5,090	5.50 m

SK210LC		Standard Arm: 2.94 m Bucket: Without Shoe: 800 mm Counterweight: 4,300 kg												
B	A	1.5 m		3.0 m		4.5 m		6.0 m		7.5 m		At Max. Reach		Radius
		Icon	Icon	Icon	Icon	Icon	Icon	Icon	Icon	Icon	Icon	Icon	Icon	
7.5 m	kg							*4,830	*4,830			*3,880	*3,880	6.26 m
6.0 m	kg							*5,330	*5,330			*3,590	*3,590	7.36 m
4.5 m	kg							*5,810	5,200	*5,340	3,640	*3,510	3,230	8.03 m
3.0 m	kg					*8,460	7,540	*6,580	4,930	5,480	3,520	*3,580	2,950	8.38 m
1.5 m	kg					*9,970	6,990	*7,330	4,670	5,340	3,400	*3,790	2,850	8.45 m
G. L.	kg			*5,760	*5,760	*10,670	6,700	7,280	4,480	5,240	3,300	*4,190	2,900	8.25 m
-1.5 m	kg	*6,100	*6,100	*10,060	*10,060	*10,510	6,620	7,190	4,410	5,210	3,280	*4,910	3,150	7.75 m
-3.0 m	kg	*10,670	*10,670	*13,190	13,020	*9,500	6,690	*7,040	4,450			*5,700	3,730	6.89 m
-4.5 m	kg			*9,760	*9,760	*7,160	6,940					*5,380	5,250	5.50 m

- Notes:**
- Do not attempt to lift or hold any load that is greater than these lifting capacities at their specified lift point radius and heights. Weight of all accessories must be deducted from the above lifting capacities.
  - Lifting capacities are based on machine standing on level, firm, and uniform ground. User must make allowance for job conditions such as soft or uneven ground, out of level conditions, side loads, sudden stopping of loads, hazardous conditions, experience of personnel, etc.
  - Arm top defined as lift point.
  - The above lifting capacities are in compliance with ISO 10567. They do not exceed 87% of hydraulic lifting capacity or 75% of tipping load. Lifting capacities marked with an asterisk (\*) are limited by hydraulic capacity rather than tipping load.
  - Operator should be fully acquainted with the Operator's and Maintenance Instructions before operating this machine. Rules for safe operation of equipment should be adhered to at all times.
  - Lifting capacities apply to only machine originally manufactured and normally equipped by KOBELCO CONSTRUCTION MACHINERY CO., LTD.

### STANDARD EQUIPMENT

- ENGINE**
- Engine, HINO J05ETG-KSSG, diesel engine with turbocharger and intercooler
  - Automatic engine deceleration
  - Auto Idle Stop (AIS)
  - Batteries (2 x 12V - 96Ah)
  - Starting motor (24V - 5 kW), 60 amp alternator
  - Automatic engine shut-down
  - Engine oil pan drain cock
  - Double element air cleaner
- CONTROL**
- Working mode selector (H-mode, S-mode and ECO-mode)
  - Power Boost
- SWING SYSTEM & TRAVEL SYSTEM**
- Swing rebound prevention system
  - Straight propel system
  - Two-speed travel with automatic shift down
  - Sealed & lubricated track links
  - Grease-type track adjusters
  - Automatic swing brake
- HYDRAULIC**
- Arm regeneration system
  - Auto warm up system
  - Aluminum hydraulic oil cooler
  - Arm interflow system
  - Hydraulic fluid filter clog detector
- MIRRORS & LIGHTS**
- Two rear view mirrors
  - Four front working lights (one for boom, one for boom cylinder, one for right storage box and one for cab)

- CAB & CONTROL**
- Two control levers, pilot-operated
  - Tow eyes
  - Horn, electric
  - Cab light (interior)
  - Luggage tray
  - Large cup holder
  - Detachable two-piece floor mat
  - Headrest
  - Handrails
  - Intermittent windshield wiper with double-spray washer
  - Skylight
  - Tinted safety glass
  - Pull-up type front window and removable lower front window
  - Easy-to-read multi-display color monitor
  - Automatic air conditioner
  - Emergency escape hammer
  - KOMEXS

### OPTIONAL EQUIPMENT

- Additional track guide
- Two cab lights
- N & B piping
- Refilling pump
- Rear view camera

Note: Standard and optional equipment may vary. Consult your KOBELCO dealer for specifics.

Note: This catalog may contain attachments and optional equipment that are not available in your area. And it may contain photographs of machines with specifications that differ from those of machines sold in your areas. Please consult your nearest KOBELCO distributor for those items you require. Specialist equipment is needed to use this machine in demolition work. Before using it please contact your KOBELCO dealer. Due to our policy of continuous product improvements all designs and specifications are subject to change without advance notice. Copyright by **KOBELCO CONSTRUCTION MACHINERY CO., LTD.** No part of this catalog may be reproduced in any manner without notice.

**KOBELCO CONSTRUCTION MACHINERY CO., LTD.**  
 5-15, Kitashinagawa 5-chome, Shinagawa-ku, Tokyo 141-8626 JAPAN  
 Tel: +81 (0) 3-5789-2146 Fax: +81 (0) 3-5789-2135  
<https://www.kobelcocm-global.com>

Inquiries To:





# Power Meets Efficiency

**16%**  
Higher fuel saving  
means  
"Efficiency"

Compared to H-mode on the SK200-8

Increase in  
productivity  
means  
"Power"



To urban centers and mines around the world. Kobelco's all-out innovation brings you durable earth-friendly construction machinery suitable for any task, and sites all over the planet. With greater fuel economy we deliver higher efficiency to any project. Kobelco SK200 SK210LC machines are also more durable than ever, able to withstand the rigors of the toughest job sites. It all adds up to new levels of value that are a step ahead of the times. While focusing on the global environment of the future, Kobelco offers next-generation productivity to meet the need for lower life cycle costs and exceed the expectations of customers globally.



## SK200 SK210<sub>LC</sub>



# Evolution Continues, with Improved Fuel Efficiency.

**16%**  
Higher fuel efficiency means "Efficiency"

The new arm interflow system more efficiently controls hydraulic fluid flow, and significant reduction of in-line resistance and pressure loss boosts fuel efficiency by about 16%\*. The electronic-control common-rail engine features high-pressure fuel injection and multiple injection with improved precision.

\* Compared to H-mode on the SK200-8



## In Pursuit of Improved Fuel Efficiency

### Operation Mode

Fuel consumption is lower in H-mode/S-mode/ECO-mode in comparison with the previous model (Generation 8).

■ Compared to previous models

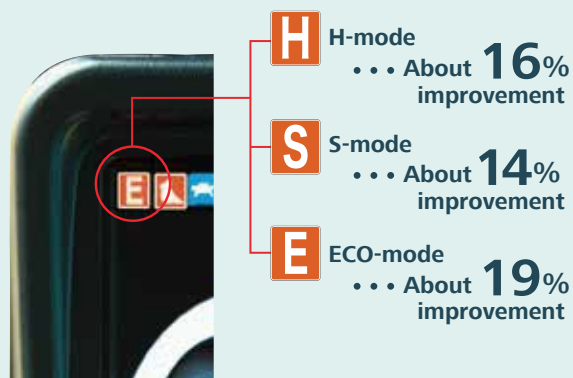

**Always and Forever. Yesterday, Today, and Tomorrow. Obsessed with Fuel Efficiency.**

Over the past 10 years, Kobelco has achieved an average reduction of about 38% in fuel consumption. And we vow to continue to lead in fuel efficiency.

■ Compared to SK210LC-6 model (2006)

**E** ECO-mode (SK210LC-10) ... About **38%** improvement

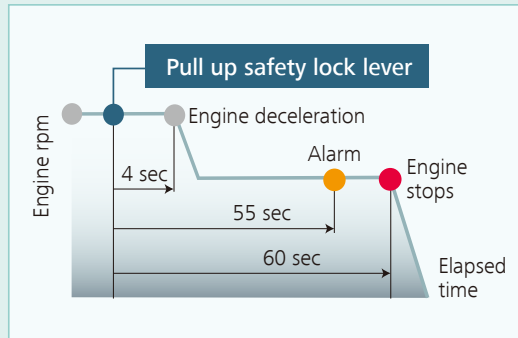

### AIS (Auto Idle Stop)

If the safety lock lever is lifted up, the engine will stop automatically. This eliminates wasteful idling during standby, saving fuel and reducing CO<sub>2</sub> emissions as well.

## Hydraulic System: Revolutionary Technology Saves Fuel

### Arm Interflow System **NEW**

When lowering the boom, this system uses the downward force generated by the boom's weight to push fluid to the arm. This greatly reduces the need to apply power from outside the system.

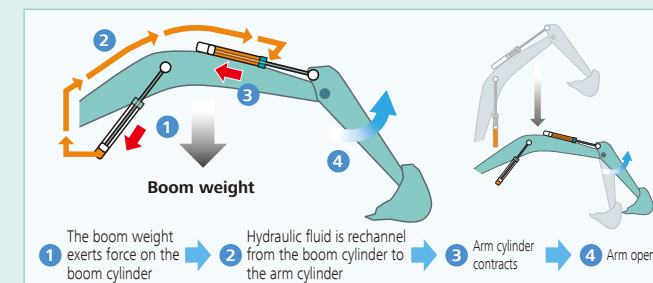

### Hydraulic Circuit Reduces Energy Loss

We have made every effort to enhance fuel efficiency by minimizing hydraulic pressure resistance, improving the hydraulic line layout to control friction resistance loss and minimizing valve resistance.

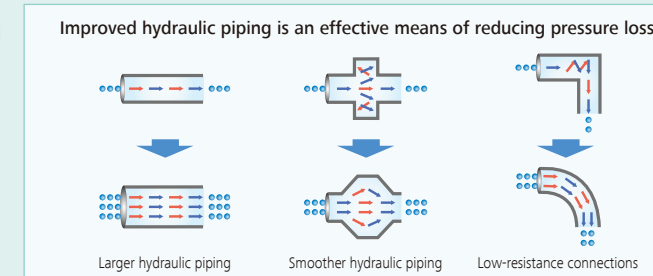

## Pursuing Maximum Fuel Efficiency

### Common Rail System

High-pressure injection atomizes the fuel, and more precise injection improves combustion efficiency. This also contributes to better fuel economy.

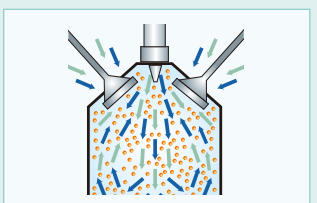



# More Power and Higher Efficiency.

The highly efficient hydraulic system minimizes fuel consumption while maximizing power. With nimble movement and Superior digging power, this excavator promises to improve your job productivity.

## Improved Fuel Efficiency Contributes to High Performance

### Superior Digging Performance

Powerful digging force delivers outstanding performance.

■ Max. Bucket Digging Force

Normal: **143kN**

With power boost: **157kN**

■ Max. Arm Crowding Force

Normal: **102kN**

With power boost: **112kN**

\*Values are for STD arm (2.94m)

## Get More Done Faster with Superior Operability

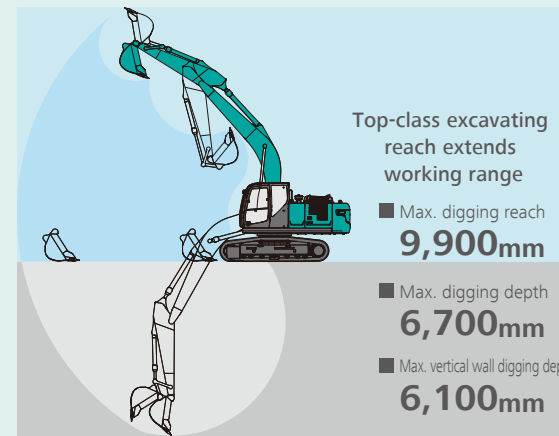

\*Values are for STD arm (2.94m)

## A Light Touch on the Lever Means Smoother, Less Tiring Work **NEW**

It takes 38% less effort to work the operation lever, which reduces fatigue over long working hours or continued operations.



## Top Class Traveling Force

Powerful traveling force and drawbar pulling force deliver plenty of speed when climbing slopes or negotiating bad roads, and the agility to change direction swiftly and smoothly.

■ Drawbar Pulling Force: **228kN**



## Operator-friendly Features Include Controls that Are Easy to See, Easy to Use



### Multi-Display in Color

Brilliant colors and graphic displays are easy to recognize on the LCD multi-display in the console. The display shows fuel consumption, maintenance intervals, and more.

- 1 Analog gauge provides an intuitive reading of fuel level and engine water temperature
- 2 Green indicator light shows low fuel consumption during operation
- 3 Fuel consumption/Switch indicator for rear camera images
- 4 Digging mode switch
- 5 Monitor display switch

### One-Touch Attachment Mode Switch

A simple touch of a button, switches the hydraulic circuit and flow amount to match attachment changes. Icons help the operator to confirm the proper configuration at a glance.

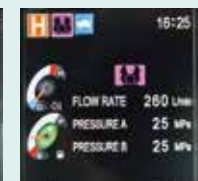



# Increased Power, with Enhanced Durability to Maintain the Machine's Value

Increase in  
productivity  
means  
"Power"

Structural design increases strength,  
while eliminating hydraulic problems.  
Enhanced durability takes  
productivity to a new level.

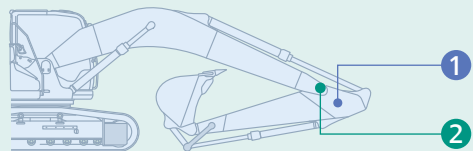

## Built to Operate in Tough Working Environments

The attachment has been reinforced to handle a higher work volume, with greater power and excellent durability that can withstand demanding work conditions.

### 1 Enlarged Reinforcement of the Arm Foot

HD: Base plate thickness has been increased 1.3 times (20 t).



### 2 Modified Foot Boss Shape

The arm foot boss shape has been modified and improved to distribute stress, delivering 2.6 times more strength for tasks like digging next to a wall.

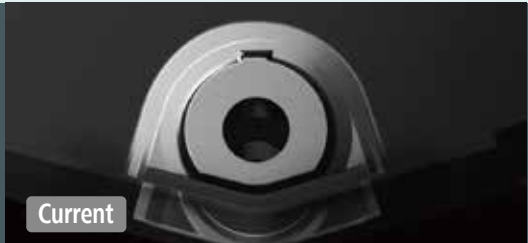

## Improved Filtration System Reliability

Clean, contaminant-free fuel and hydraulic fluid are essential to stable performance. The improved filtration systems reduce the risk of mechanical trouble and enhance longevity and durability.

### Hydraulic Fluid Filter

Recognized as the best in the industry, our super-fine filter separates out even the smallest particles. New cover prevents contamination when changing filters.



### Hydraulic Fluid Filter Clog Detector

Hydraulic tank pressure sensor monitors the pressure difference between the return line and tank inside pressure to determine the degree of clogging. If the difference exceeds a predetermined level, a warning appears on the multi-display, so any contamination can be trapped by the filter and replaced before it reaches the hydraulic fluid in the tank.

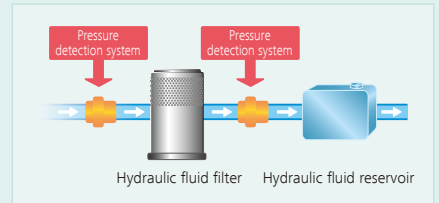

### Metal Mesh Cover Air Cleaner

Metal mesh cover ensures strength and durability.



### Fuel Filter

The pre-filter with built-in water-separator has 1.6 times more filter area compared to the previous models and with a new final stage maintenance free fuel filter to maximize filtering performance.

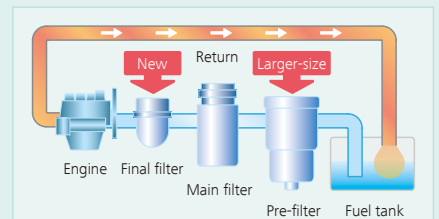



# Comfortable Cab Is Now Safer than Ever.

A work environment that is quieter and more comfortable. A cab that puts the operator first is key to improved safety.



## Comfort

### Super-Airtight Cab



The high level of air-tightness keeps dust out of the cab.

### Quiet Inside

The high level of air-tightness ensures a quiet, comfortable cabin interior.

### Low Vibration

Coil springs absorb small vibrations, and high suspension mounts filled with silicone oil reduce heavy vibration. The long stroke achieved by this system provides excellent protection from vibration.

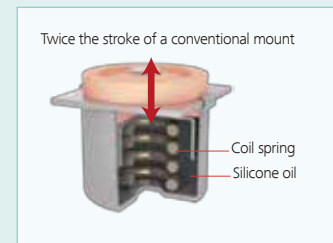

### Air Conditioner Louvers behind the Seat NEW



The large air-conditioner has louvers on the back pillars that blow from behind and to the right and left of the operator's seat. They can be adjusted to put a direct flow of cool/warm air on the operator, which means a more comfortable operating environment.

### More Comfortable Seat Means Higher Productivity



Seat recliner can be pushed back flat



Double slides allow adjustment for optimum comfort

### Large Cab Is Easy to Get in and Out of

The expanded cab provides plenty of room for a large door, more headroom and smoother entry and exit.



### Interior Equipment Adds to Comfort and Convenience

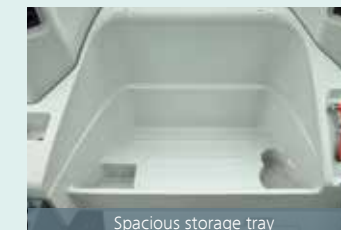

Spacious storage tray



Large cup holder

## Safety

### ROPS Cab

ROPS (Roll-Over-Protective Structure)-compliant cab clears ISO standards (ISO-12117-2: 2008) and ensures greater safety for the operator should the machine tip over.



### Broad View Liberates the Operator

The front window features one large piece of glass without a center pillar on the right side for a wide, unobstructed view.

### Expanded Field of View for Greater Safety



Rearview mirrors left and right

Greater safety assured by rearview mirrors on left and right.



Rear view

Rear view shows the area directly behind the cab.

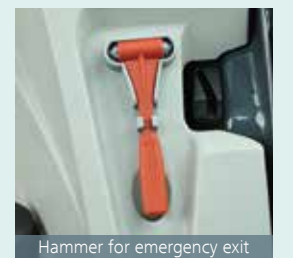

Hammer for emergency exit



Rear view camera (option)

A rear view camera is installed as option to simplify checking for safety behind the machine. The picture appears on the color monitor.



# Efficient Maintenance Keeps the Machine in Peak Operating Condition.



MAINTENANCE			
	INTERVAL	REMAINING TIME	EXCHANGE DAY
ENGINE OIL	500	495	--/--/--
FUEL FILTER	500	495	--/--/--
HYD. FILTER	1000	995	--/--/--
HYD. OIL	2000	1995	--/--/--

6.7h

## Machine Information Display Function

- Displays only the maintenance information that's needed, when it's needed
- Self-diagnostic function provides early-warning detection and display of electrical system malfunctions
- Service-diagnostic function makes it easier to check the status of the machine
- Record function of previous breakdowns including irregular and transient malfunction

Examples of displaying maintenance information

## Easy, On-the-Spot Maintenance NEW

There is ample space in the engine compartment for a mechanic to do maintenance work inside. The distance between steps is lower so entry and exit is easier. And the mechanic can work in comfort, without contortions or unnatural body positions. Finally, the engine hood is lighter and easier to raise and lower.



## Maintenance Work, Daily Checks, Etc., Can Be Done from Ground Level

The layout allows for easy access from the ground for many daily checks and regular maintenance tasks.



- 1 Fuel filter
- 2 Fuel filter with built-in water-separator
- 3 Engine oil filter

Simple layout for easy access to radiator and cooling system elements.

## More Efficient Maintenance Inside the Cab



Internal and external air conditioner filters can be easily removed without tools for cleaning.

## Easy Cleaning

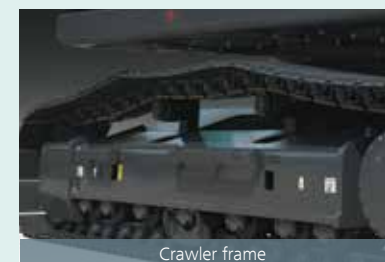

Special crawler frame design for easy mud removal cleaning.

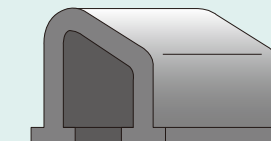

Detachable two-piece floor mat with handles for easy removal. A floor drain is located under floor mat.

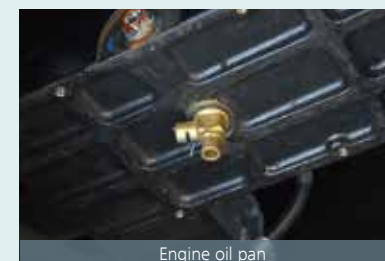

Engine oil pan equipped with drain valve.

Long-life hydraulic oil:  
**2,000**  
hours

Replacement cycle:  
**1,000**  
hours

## Long-Interval Maintenance

Long-life hydraulic oil reduces cost and labor.

## Highly Durable Premium-fine Filter

The high-capacity hydraulic oil filter incorporates glass fiber with superior cleaning power and durability.



## KOMEXS

KOMEXS is the remote monitoring system for SK series excavators. When a hydraulic excavator is fitted with this system, data on the machine's operation, such as operating hours, location, fuel consumption, and maintenance status can be obtained remotely.







## Engine

Model	HINO J05ETG-KSSG
Type:	Four-stroke liquid-cooled direct injection diesel turbo charged with intercooler
No. of cylinders:	4
Bore and stroke:	112 mm x 130 mm
Displacement:	5.123 L
Rated power output:	114 kW/2,000 min <sup>-1</sup> (ISO 9249)
	118 kW/2,000 min <sup>-1</sup> (ISO 14396)
Max. torque:	569 N·m/1,600 min <sup>-1</sup> (ISO 9249)
	592 N·m/1,600 min <sup>-1</sup> (ISO 14396)



## Hydraulic System

Pump	
Type:	Two Variable displacement piston pumps + one gear pump
Max. discharge flow:	2 x 220 L/min, 1 x 21 L/min
Relief valve setting	
Boom, arm and bucket:	34.3 MPa {350 kgf/cm <sup>2</sup> }
Power Boost:	37.8 MPa {385 kgf/cm <sup>2</sup> }
Travel circuit:	34.3 MPa {350 kgf/cm <sup>2</sup> }
Swing circuit:	29.0 MPa {296 kgf/cm <sup>2</sup> }
Control circuit:	5.0 MPa {50 kgf/cm <sup>2</sup> }
Pilot control pump:	Gear type
Main control valve:	8-spool valve
Oil cooler:	Air cooled type



## Swing System

Swing motor:	One fixed displacement piston pump
Brake:	Hydraulic; locking automatically when the swing control lever is in the neutral position
Parking brake:	Wet multiple plate
Swing speed:	13.3 min <sup>-1</sup> {rpm}
Tail swing radius:	2,910 mm
Min. front swing radius:	3,550 mm



## Attachments

Backhoe bucket and combination

Type	Backhoe bucket					
Bucket capacity	ISO heaped	m <sup>3</sup>	0.80	0.80 Side pin type	0.93	0.93 Side pin type
	ISO Struck	m <sup>3</sup>	0.59	0.59	0.67	0.67
Opening width	With side cutter	mm	1,160	1,160	1,330	1,300
	Without side cutter	mm	1,140	1,060	1,230	1,200
No. of teeth			5	5	5	5
Bucket weight		kg	640	730	710	790
Combination	2.94m standard arm		○	○	◎	○

◎ Standard combination ○ General operation

## Operating Weight & Ground Pressure

In standard trim, with standard boom, 2.94 m arm, and 0.93 m<sup>3</sup> ISO heaped bucket

Shaped		Triple grouser shoes (even height)		
Shoe width	mm	600	700	800
Overall width of crawler	mm SK200	2,800	2,900	3,000
	mm SK210LC	2,990	3,090	3,190
Ground pressure	kPa SK200	46	41	36
	kPa SK210LC	44	38	34
Operating weight	kg SK200	20,700	21,100	21,400
	kg SK210LC	21,100	21,600	21,800



## Travel System

Travel motors:	Variable displacement piston pump
Travel brakes:	Hydraulic
Parking brakes:	Wet multiple plate
Travel shoes:	46 each side (SK200)
	49 each side (SK210LC)
Travel speed:	6.0/3.6 km/h
Drawbar pulling force:	228 kN (ISO 7464)
Gradeability:	70 % {35°}
Ground clearance:	450 mm



## Cab & Control

Cab	
All-weather, sound-suppressed steel cab mounted on the high suspension mounts filled with silicone oil and equipped with a heavy, insulated floor mat.	
Control	
Two hand levers and two foot pedals for travel	
Two hand levers for excavating and swing	
Electric rotary-type engine throttle	



## Boom, Arm & Bucket

Boom cylinders:	120 mm x 1,355 mm
Arm cylinder:	135 mm x 1,558 mm
Bucket cylinder:	120 mm x 1,080 mm



## Refilling Capacities & Lubrications

Fuel tank:	320 L
Cooling system:	18 L
Engine oil:	20.5 L
Travel reduction gear:	2 x 5 L
Swing reduction gear:	5 L
Hydraulic oil tank:	140 L tank oil level
	244 L hydraulic system



## Working Ranges

Boom		Standard
Range	Arm	2.94 m
a- Max. digging reach		9.9
b- Max. digging reach at ground level		9.73
c- Max. digging depth		6.7
d- Max. digging height		9.72
e- Max. dumping clearance		6.91
f- Min. dumping clearance		2.43
g- Max. vertical wall digging depth		6.1
h- Min. swing radius		3.55
i- Horizontal digging stroke at ground level		5.27
j- Digging depth for 2.4 m (8') flat bottom		6.52
Bucket capacity ISO heaped m <sup>3</sup>		0.93

Unit: m

Digging Force (ISO 6015)		Standard
Arm length		2.94 m
Bucket digging force		143
		157*
Arm crowding force		102
		112*

Unit: kN

\*Power Boost engaged.

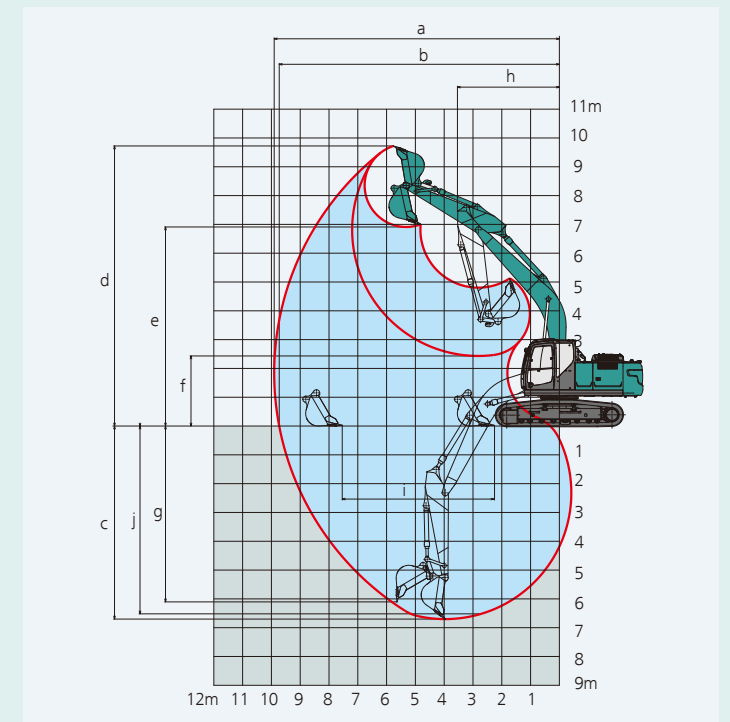

## Dimensions

Arm length		Standard
A Overall length		9,600
B Overall height (to top of boom)		2,980
C Overall width of crawler	SK200	2,800
	SK210LC	2,990
D Overall height (to top of cab)		3,010
E Ground clearance of rear end*		1,060
F Ground clearance*		450
G Tail swing radius		2,910

Dimensions			Unit: mm
G'	Distance from center of swing to rear end		2,900
H	Tumbler distance	SK200	3,370
		SK210LC	3,660
I	Overall length of crawler	SK200	4,170
		SK210LC	4,450
J	Track gauge	SK200	2,200
		SK210LC	2,390
K	Shoe width		600
L	Overall width of upperstructure		2,710

\*Without including height of shoe

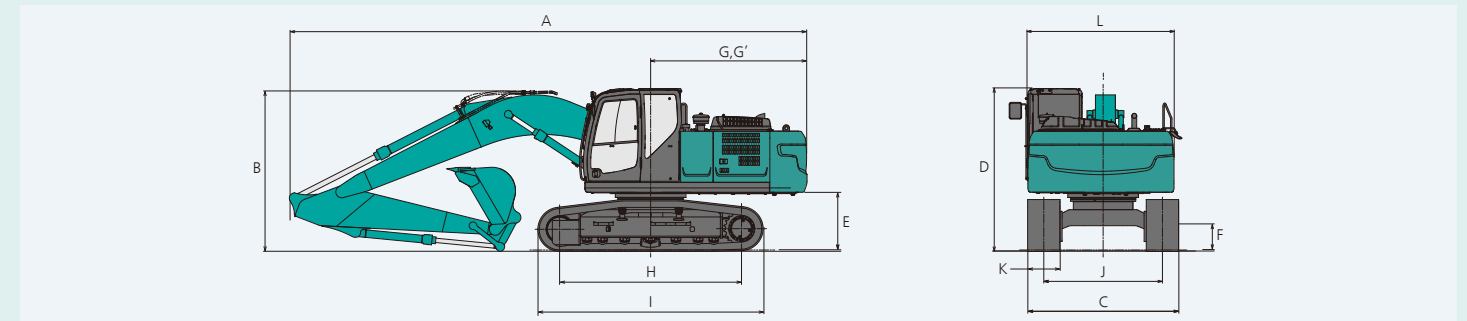

## Lifting Capacities

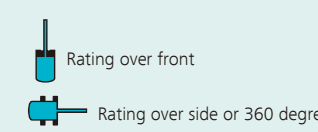
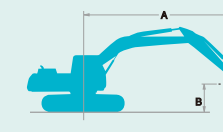

A: Reach from swing centerline to arm top  
 B: Arm top height above/below ground  
 C: Lifting capacities in Kilograms  
 Bucket: Without bucket  
 Relief valve setting: 34.3 MPa (350 kgf/cm<sup>2</sup>)

SK200	Standard Arm: 2.94 m Bucket: Without Shoe: 600 mm Counterweight: 4,300 kg													
	1.5 m		3.0 m		4.5 m		6.0 m		7.5 m		At Max. Reach			
B	Rating over front	Rating over side or 360 degrees	Rating over front	Rating over side or 360 degrees	Rating over front	Rating over side or 360 degrees	Rating over front	Rating over side or 360 degrees	Rating over front	Rating over side or 360 degrees	Radius			
7.5 m	kg						*4,830	4,770			*3,880	*3,880	6.26 m	
6.0 m	kg						*5,330	4,760			*3,590	3,340	7.36 m	
4.5 m	kg						*5,810	4,580	4,850	3,190	*3,510	2,830	8.03 m	
3.0 m	kg					*8,460	6,580	*6,580	4,320	4,720	3,080	*3,580	2,570	8.38 m
1.5 m	kg					*9,970	6,040	6,390	4,060	4,590	2,950	*3,790	2,470	8.45 m
G. L.	kg			*5,760	*5,760	9,640	5,760	6,190	3,880	4,490	2,860	3,920	2,510	8.25 m
-1.5 m	kg	*6,100	*6,100	*10,060	*10,060	9,550	5,680	6,110	3,810	4,460	2,840	4,270	2,720	7.75 m
-3.0 m	kg	*10,670	*10,670	*13,190	10,980	*9,500	5,750	6,160	3,850			5,090	3,240	6.89 m
-4.5 m	kg			*9,760	*9,760	*7,160	5,990					*5,380	4,560	5.50 m